

© COPYRIGHT VULCANITE PTY LTD. ALL RIGHTS RESERVED. DRAWING PROVIDED FOR INFORMATION PURPOSES ONLY. VULCANITE RESERVES THE RIGHT TO CHANGE DIMENSIONS AND/OR SPECIFICATION AT ANY TIME.

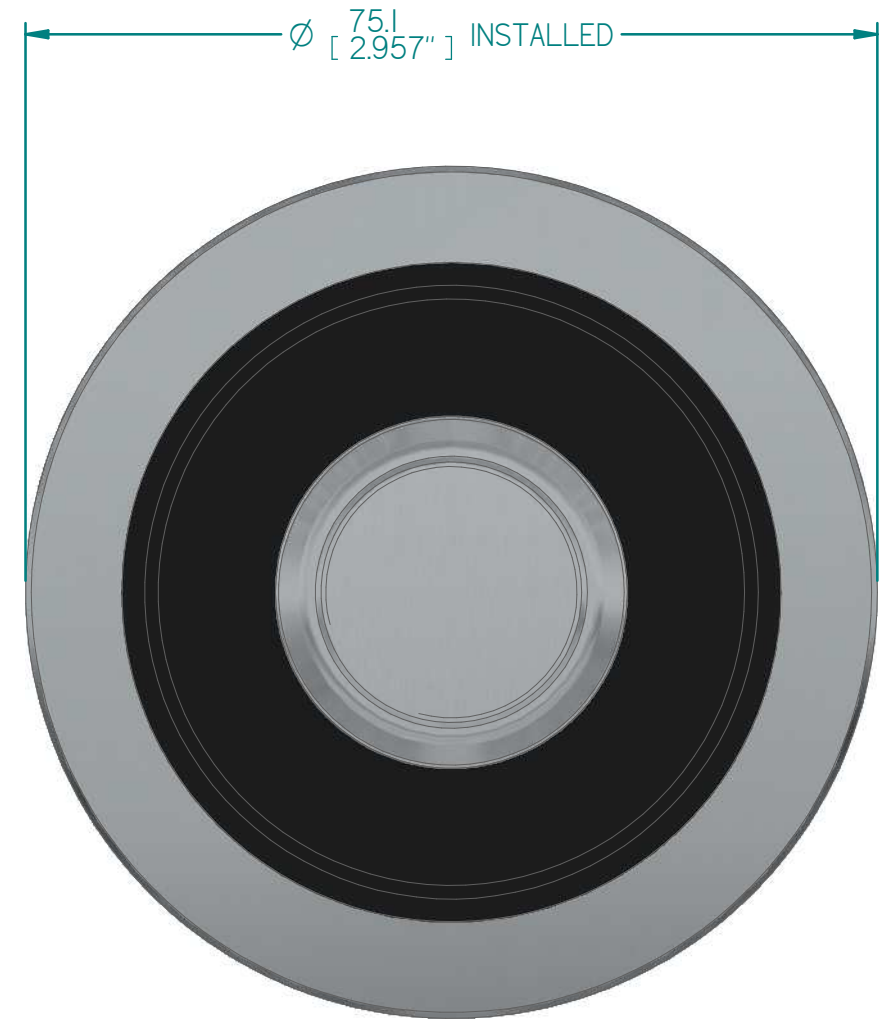
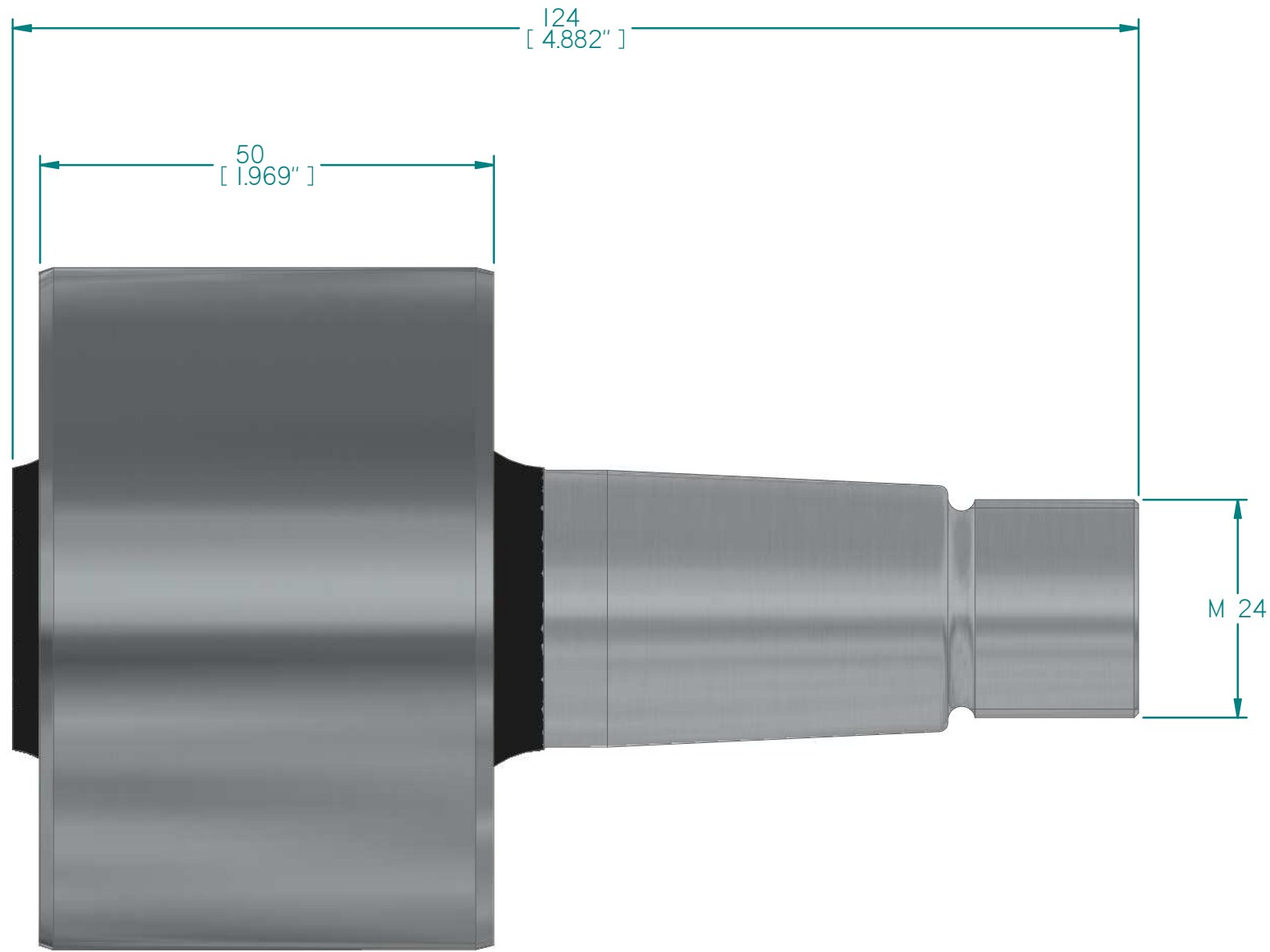

FOR SPECIFICATION
REFER TO
VULCANITE.COM.AU

AS 1100.201-1992	
0 - 6	±0.1
6 - 30	±0.2
30 - 120	±0.3
120 - 400	±0.5
400 - 1000	±0.8

UNLESS OTHERWISE SPECIFIED, TOLERANCE ON ALL DIMENSION OF LENGTH AND ANGLE ON RUBBER ARE TO CLASS M3 OF STANDARD ISO 3302-1: 1996 AND ON METAL ARE TO AS 1100.201-1992 AND ASI365-1986

ISO 3302-1: 1996 CLASS M3			
RANGE	SPEC	25 - 40	±0.60
0 - 6.3	±0.25	40 - 63	±0.80
6.3 - 10	±0.30	63 - 100	±1.00
10 - 16	±0.40	100 - 160	±1.30
16 - 25	±0.50	160 -	±0.8%

ELASTOMER SPEC:	NATURAL RUBBER
METAL SPEC:	1045 STEEL
FINISH:	RUST VETO
WEIGHT:	1.70 [3.74 lbs]

ALL DIMENSIONS ARE IN MILLIMETRES WITH INCHES SHOWN INSIDE []	
NOT TO SCALE	
SIZE:	A3
THIRD ANGLE PROJECTION	

 Excellence in engineered rubber solutions.		 VULCANITE PTY LTD ABN 62 000 055 089	
			TITLE:
SUB-TITLE:		DWG No:	VP2761